

Monitoring biodiesel production (transesterification) using in situ viscometer

Naoko Ellis*, Feng Guan, Tim Chen, Conrad Poon

Department of Chemical and Biological Engineering, University of British Columbia, Vancouver, Canada

Received 29 August 2006; received in revised form 11 June 2007; accepted 29 June 2007

Abstract

Biodiesel, an alternative diesel fuel made from renewable sources, is produced by the transesterification of oil or fat with alcohol. In order to monitor the progress of this reaction, in situ viscosity measurements were taken using an acoustic wave solid state viscometer. This novel concept is reported from the proof-of-concept stage to a pilot plant installation. The viscometer was able to monitor the reaction until the end-point was reached, and could therefore be adapted in the future for process control in a batch transesterification reactor for biodiesel production.

© 2007 Elsevier B.V. All rights reserved.

Keywords: Biodiesel; In situ viscosity measurement; Transesterification; Process monitor

1. Introduction

Biodiesel is becoming well-known as an environmentally friendly fuel due to its non-toxic and biodegradable characteristics. It has reduced engine emissions of sulphur oxides, particulate matter and hydrocarbons and, in terms of the carbon cycle, it is a carbon neutral fuel [1]. Furthermore, biodiesel can be produced from renewable resources, such as vegetable oil, animal fats and waste cooking oil. In Europe and North America, the demand for biodiesel has steadily increased along with government subsidies to promote renewable and alternative fuels. In May 2006 the Federal Government of Canada set a target of 5% biofuel content in Canada by 2010. Currently, petroleum fuel still dominates the market due to its favourable economics. The average price per gallon of diesel in the USA in June 2006 was \$2.98. B20 (20% biodiesel plus 80% diesel) was \$2.92, and B100 (100% biodiesel) was \$3.76 [2]. However, the dedication of laboratory and industrial investigators to increase the efficiency of biodiesel production will result in a greater availability of biodiesel; and prices will, therefore, become increasingly competitive. Thus, the use of biodiesel may soon supplement or possibly replace diesel oil in some applications such as marine engines and domestic heating.

Biodiesel is produced by converting triglycerides to alkyl esters. This reaction step has the largest effect on the quality and quantity of the final product. An unsuccessful reaction step for the alkali catalyzed transesterification reaction is most likely caused by a high water or free fatty acid contents and results in a partial or incomplete conversion of the triglycerides, thus adding complexity to the purification step. It is therefore advantageous to be able to monitor the transesterification reaction until the end-point.

Conversion and quality analyses of biodiesel are commonly done by chromatographic methods [3,4]. These methods are suitable for laboratory scale analysis, providing detailed composition of the products. However, some of the draw backs are high cost, extensive sample preparation and no real time indication.

Size exclusion chromatography (SEC) and Fourier-transformed infrared spectroscopy (FTIR) were used to monitor reaction yields in a study by Zagonel et al. [5]. This allowed the direct monitoring of conversion rates inside the transesterification vessel, though no details were given on how this was done.

Knothe [6] monitored the transesterification of model compounds using NIR spectroscopy with a fibre optic probe. One of the challenges in this method was that the peaks of interest were not resolved from others such as that of methanol. In the acid catalyzed transesterification reaction, alcohol-to-oil ratio can be as high as 30:1 [7] in order to drive the equilibrium shift toward the product side. Monitoring such a reaction would be difficult due to the broad peaks presented by the alcohol. In a subsequent study, Knothe [8] used NIR to quantitatively monitor the

* Corresponding author. Tel.: +1 604 822 1243; fax: +1 604 822 6003.
E-mail address: nellis@chml.ubc.ca (N. Ellis).

Nomenclature

ASTM	American Society for Testing and Materials
AV	acoustic viscosity
C	carbon
DG	diglyceride
FAME	fatty acid methyl ester
k	reaction rate ($\text{dm}^3 \text{mol}^{-1} \text{min}^{-1}$)
KOCH_3	potassium methoxide
M	methanol
MG	monoglyceride
TG	triglyceride
w	mass fraction of component j
WVO	waste vegetable oil

Greek letter

η	viscosity of pure component j (mPa s)
--------	---

transesterification reaction by correlating the NIR data with ^1H nuclear magnetic resonance spectroscopy (NMR) results. The study used neat vegetable oil as feedstock, which is relatively free from contaminants. Thus, the application of this method to monitor conversion of waste vegetable oil (WVO) would require further investigation.

Another study utilized a flexible fuel composition sensor to determine the composition of biodiesel/diesel blends [9]. Although the study only focused on the testing and determination of different biodiesel, diesel, and biodiesel/diesel fuel blends, the analytical methods could be extended to an in situ measurement in a reactor. Two sensors were discussed in the article: the optical fuel composition sensor; and the dielectric fuel composition sensor. The dielectric sensor was found to be more reliable since it was less sensitive to phase changes and the presence of water compared to the optical sensor. The dielectric sensor was basically a circuit with two resistors and a capacitor that reflects the difference in the dielectric constant of fuels flowing between concentric cylinders. Due to its easy implementation, this is a feasible option which could be further investigated.

In industrial transesterification processes, a considerable amount of information can be gained through the continuous monitoring of the viscosity of a reaction mixture. In situ viscosity measurements in other applications have been reported [10,11]. Kleinschmidt [10] studied methods that would enable the viscosity of resin melts to be measured continuously in stirred vessels during manufacture. The instrument utilizes a vibrating blade of magnetostrictive material to measure the viscosity. In situ measurements were correlated with results from an off line instrument. Cullen and O'Donnell [11] evaluated viscometers for use in process monitoring of complex fluids in the food industry. The study focused on the suitability and limitations of these instruments for a range of food process applications.

A correlation between the methyl ester content and the viscosity of a biodiesel mixture has been reported [12]. However to date, there has been no study in which the viscosity of biodiesel

has been measured in situ; nor has there been a study in which the viscosity of a reaction mixture containing glycerol – a biproduct of biodiesel production – has been monitored. We report here a novel method of continuously monitoring the transesterification reaction to its end-point by measuring changes in the viscosity of the reaction mixture. The acoustic wave solid state viscometer allows in situ measurement of the viscosity as the methyl ester conversion takes place in a reactor. The applicability of this method has been tested from bench top scale to pilot plant scale.

2. Background

Biodiesel (alkyl ester) is commonly produced by the transesterification of a lipid feedstock. As indicated in Eq. (1), transesterification is the reversible reaction of a fat or oil (both of which are composed of triglycerides and free fatty acids) with an alcohol to form fatty acid alkyl esters and glycerol. It can be alkali-, acid-, or enzyme-catalyzed; however, enzyme catalysts are rarely used as they are less effective [13]. The reaction can also take place without the use of a catalyst under conditions in which the alcohol is in a supercritical state [14,15]. Currently the majority of the commercialized technology resides in transesterification using alkali catalyzed reaction.

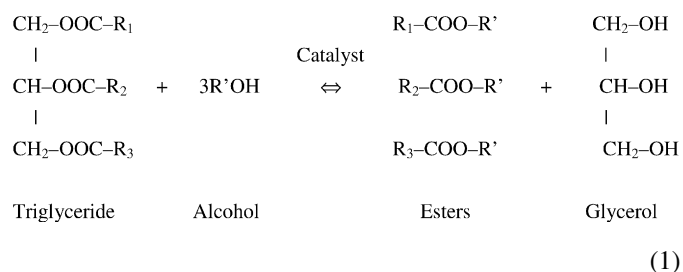

The reaction mechanism for the alkali catalyzed transesterification was formulated in three steps [13]. The first step involves the triglyceride molecule being attacked by an anion from the methanol to form a fatty acid methyl ester (FAME) and diglyceride (Reaction (2)). This is followed by the diglyceride undergoing the same mechanism to form the second FAME and monoglyceride in Reaction (3). Finally, the monoglyceride is converted to a third FAME and glycerol in a same manner (Reaction (4)). The reaction rate constants (listed in Table 1) for each step examined by Komers et al. [16] are shown for the following

Table 1
Rate constants for each transesterification step in Eqs. (2)–(4)

Forward	
k_1 ($\text{dm}^3 \text{mol}^{-1} \text{min}^{-1}$)	5.005
k_2 ($\text{dm}^3 \text{mol}^{-1} \text{min}^{-1}$)	4.929
k_3 ($\text{dm}^3 \text{mol}^{-1} \text{min}^{-1}$)	29.67
Reverse	
k_4 ($\text{dm}^3 \text{mol}^{-1} \text{min}^{-1}$)	3.545
k_5 ($\text{dm}^3 \text{mol}^{-1} \text{min}^{-1}$)	2.987
k_6 ($\text{dm}^3 \text{mol}^{-1} \text{min}^{-1}$)	0.7932

Source: [16].

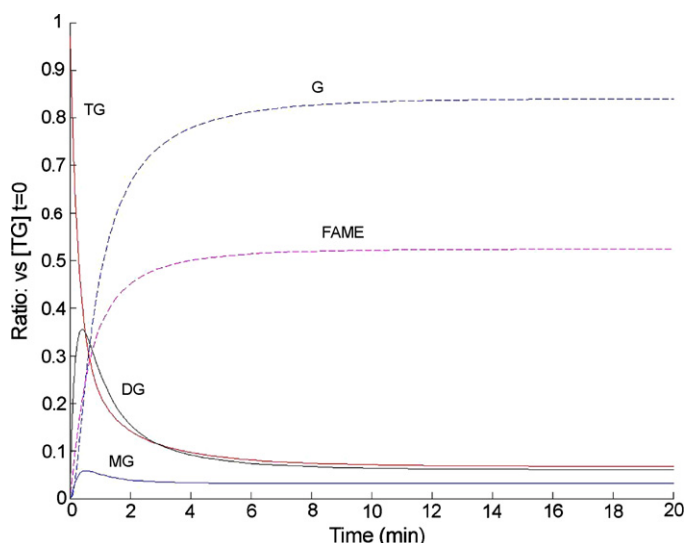

Fig. 1. Simulated concentration profile of glycerol (G), tri-glyceride (TG), di-glyceride (DG), mono-glyceride (MG) and fatty acid methyl ester (FAME) during transesterification.

equations:



A small amount of water present in the feed, or an esterification reaction of free fatty acid in the feed producing water may cause soap formation through saponification reaction which reduces the conversion of FAME.

Based on the kinetic study by Komers et al. [16], rate constants for each transesterification step can be used to simulate the reaction. A simulation program based on MATLAB 6.1 was used to generate the results shown in Fig. 1. The concentration profile of all components reaches a plateau at equilibrium, in agreement with Komers et al. [16]. The curves indicate the time series of the composition in the reaction mixture; furthermore, the progress of the transesterification can be followed by monitoring the viscosity of the mixture in the reactor based on the compositional change. This is because the reactants and the products have different viscosities. By assuming that the mixture behaves ideally – i.e., that the interactions between each of the components are small enough to be neglected – the Grunberg–Nissan equation [17] can be simplified such that the total viscosity of the mixture is equal to the product sum of mass fraction and natural logarithm viscosity of each component in the mixture, as shown in Eq. (5) [18].

$$\ln \eta_{\text{mix}} = \sum w_j \ln \eta_j \quad (5)$$

In two previous studies, the Grunberg–Nissan type of correlation equation has been applied, in a similar way, to mixtures of

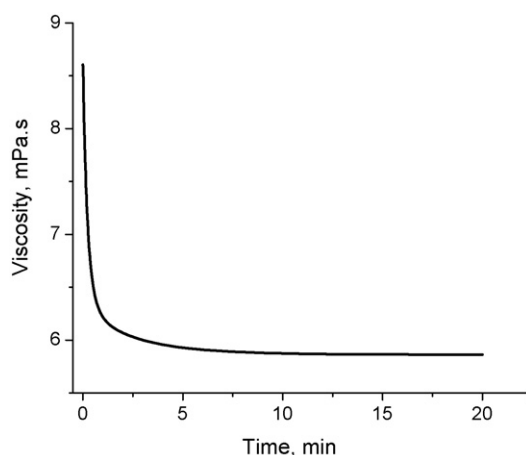

Fig. 2. Viscosity change of biodiesel mixture calculated by Irving equation.

biodiesel with or without petroleum diesel [9,18]. Prior to the transesterification reaction, the viscosity of the mixture would have similar values to triglycerides alone (e.g. 15 mPa s depending on the quality of WVO) because the weight fraction of triglycerides is the highest at initial stages. Once, the reaction has reached steady state, the overall viscosity value will have dropped to an average reading of 6.2 mPa s [19]. A simulated (using the simplified equation) plot of the viscosity of a biodiesel mixture undergoing transesterification is shown in Fig. 2. The progress of the reaction is clearly indicated by the decreasing viscosity of the mixture; the viscosity reaches a plateau once the reaction has attained steady state. The feasibility of this monitoring technique is proven by installing an online real-time viscometer in the pilot plant reactor.

3. Experimental

Three types of experiments were conducted to validate the concept of using viscosity measurements to monitor the extent of transesterification during biodiesel production. First, a rotary viscometer was used to continuously monitor the viscosity as the catalyst and alcohol mixture was added to the feed at a pre-set temperature. The sensor functioned both as a reactor and a mixer in the transesterification reaction. Secondly, an in situ viscometer was calibrated and applied to a bench top scale experiment. Finally, the in situ viscometer was mounted inside a pilot plant scale 300 L batch reactor.

3.1. Rotary viscometer experiment

The transesterification reaction was continuously monitored using a Haake 500 rotary viscometer with an NV sensor (operating range of 1.5–2000 mPa s) at 60 °C. The sensor also served as the reaction vessel, and the rotation of the inner sensor bell provided the agitation required for the reaction to proceed. The built in water jacket allowed the reaction vessel to be maintained at a constant temperature. Preliminary testing indicated a linear relationship between shear stress and shear rate for vegetable oil, waste vegetable oil and their biodiesel mixtures, confirming that all were Newtonian fluids within the temperature range studied.

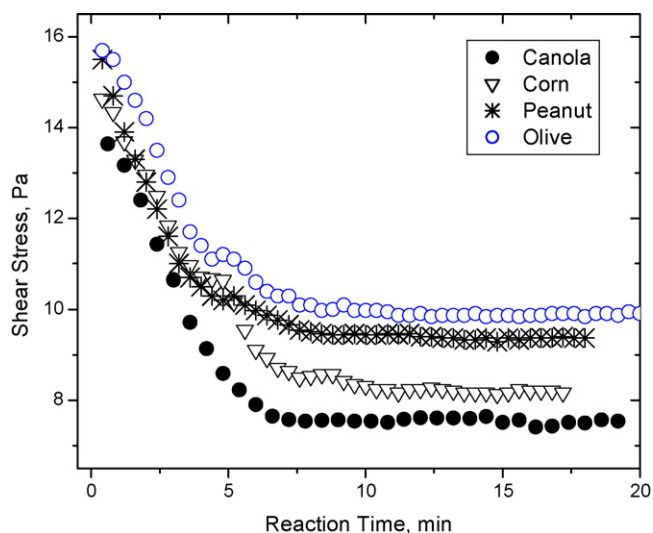

Fig. 3. Comparison of change in shear stress of reaction mixture with time for different feedstock oil.

A mixture of methanol and potassium hydroxide as alkali catalyst resulting in KOCH_3 , is prepared in advance and injected into the bottom of the sensor with a custom made long tip syringe. As the transesterification reaction proceeded, the composition inside the sensor continuously changed due to the change in weight fraction of each component until it reached equilibrium. Shear stress data was logged every 24 s for 20 min. Various oils were used as feedstock including canola, corn, peanut, olive and waste vegetable. As shown in Fig. 3, for all the oils, the shear stress is reduced with time until a plateau is reached. The triglycerides of the vegetable oils examined are mainly composed of fatty acids of C16:0, C18:0, C20:0, C22:0, C24:0, C18:1, C22:1, C18:2, and C18:3. (The first number is the carbon number of the fatty acid; the second number is the number of double bonds within the fatty acid.) Different vegetable oils have unique combinations of these hydrocarbon chains. The similar reaction curves displayed by different vegetable oils imply that a mixture of vegetable oils should bear a similar trend when reacting with KOCH_3 . WVO is a combination of several kinds of vegetable oils, and have shown a similar pattern.

Based on repeated experiments under the same reaction conditions, the viscosity of each pure vegetable oil feed is plotted against the viscosity of its corresponding biodiesel product (Fig. 4). No direct relation was found between the viscosity of feed oil and biodiesel product. The viscosity of WVO is likely to vary from batch to batch because it is a mixture of several vegetable oils. When used as a feedstock, viscosities of the resultant biodiesel mixture will also vary batch to batch. In such cases, the absolute value of the biodiesel mixture viscosity cannot give any useful indication as to the extent of the transesterification reaction. However, by measuring shear stress with time, the plateau of the shear stress curve gives a good indication that the end-point has been reached.

Fig. 5 shows the typical response curve from the Haake viscometer when the transesterification reaction has failed. The WVO sample was reacted with the catalyst alcohol mixture without the initial removal of water. Thus, it is suspected that

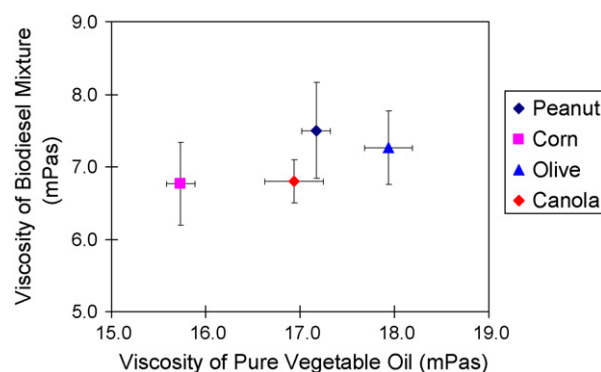

Fig. 4. Typical change in shear stress of reaction mixture for failed reaction: 7 mL WVO, 1.4 mL KOCH_3 , $T = 60^\circ\text{C}$.

saponification occurred resulting in minimal decrease in viscosity. This was confirmed visually whereby a clear phase separation between FAME and glycerol was not observed. In these experiments, the in situ viscometer allowed direct monitoring of reactions to their end-point and also revealed a failed reaction.

3.2. In situ viscosity measurement

Several commercially available process viscometers were considered for the in situ monitoring of transesterification reactions. The main factors included cost, reliability, temperature sensing, and possible extension of probe for pilot plant installation. All but one sensor that we found were of the conventional flange and probe type where the viscosity of fluid is measured by rotating probes that measure the shear. One sensor by BiODE (known currently as Gardco) called ViSmartTM measures the acoustic viscosity without any moving parts [20]. It is tiny (the size of a matchbox), fast, durable, less expensive and is amenable to installation in a pilot scale process.

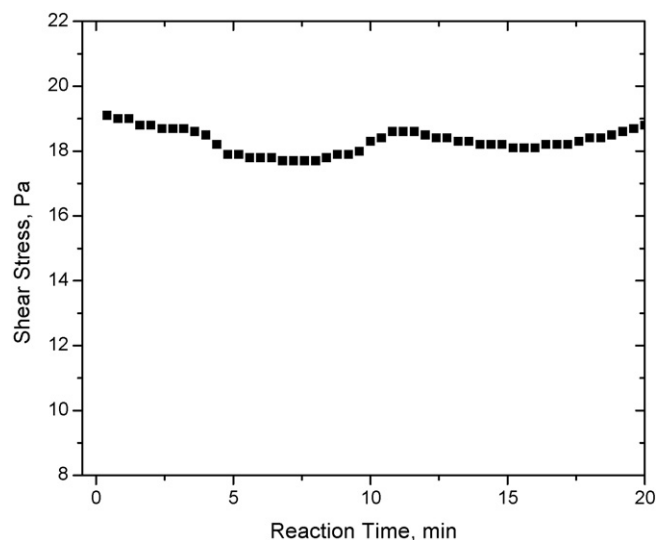

Fig. 5. Viscosity comparison of pure feedstock oil and their biodiesel mixture after transesterification reaction.

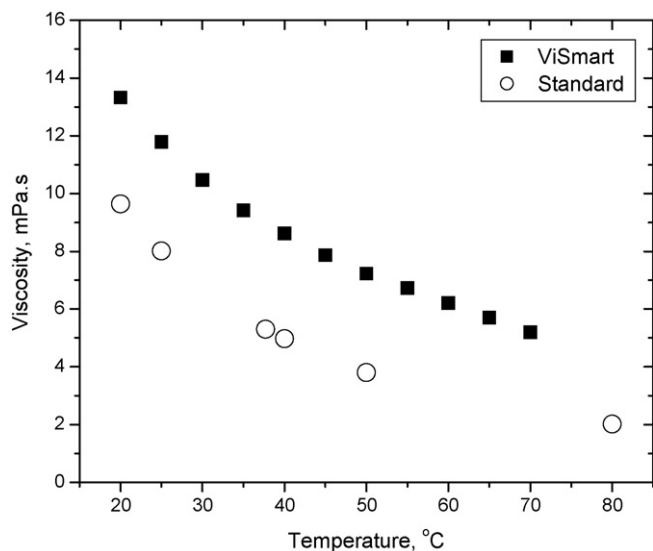

Fig. 6. Comparison of viscosity measurement using ViSmart and values reported by manufacture for standard solution.

The sensor is a semiconductor built to continuously measure viscosity and temperature and can determine the viscosity of a liquid instantaneously using as little as 100 mL [21]. A quartz oscillator in the device generates resonance waves which travel through the liquid film to an acoustic sensor that detects the amount of waves that are absorbed by the media. Data is outputted through an extension cord to a handheld device with LCD screen. Data can also be logged to a computer or a controlling device.

Acoustic viscosity is a function of the absolute (dynamic) viscosity, the density of fluid, and the frequency of vibration. Through the means of acoustic viscosity, process engineers can monitor the process more effectively without considering the inter-dependence of density and viscosity of the mixture. Thus, when comparing viscosity measurements made with the acoustic wave viscometer to measurements made with other viscometers, measurements with other viscosity instruments require an extra step of measuring the density of a sample.

The sensor was calibrated for viscosity and temperature responses on a bench top scale. As shown in Fig. 6, viscosity measurements were compared against Canon Certified Standards and indicated an off set ranging between 38.3 and 47.4% owing mostly to the high shear rate of the sensor. However, all the viscosity measurements between 5.2 and 13.3 mPa.s within the measured temperature (20.0–70.0 °C) showed good reproducibility as indicated by the low standard deviations of 0.08–0.35 mPa.s. Temperature calibration was conducted in water against thermometer readings. Offset readings of -1.57 to 1.20 °C were observed for temperatures ranging between 15.0 and 70.0 °C with standard deviations of 0.38 and 0.95 °C. Thus the sensor can monitor the changes in viscosity and temperature of the standards; moreover, the ability to monitor transesterification was demonstrated as follows.

Continuous monitoring of acoustic viscosity during transesterification of canola oil and waste vegetable oil was conducted at 60 °C. Fig. 7 indicates a typical change in acoustic viscosity and

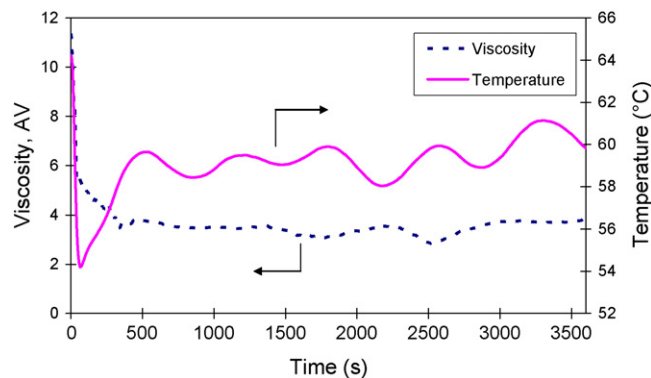

Fig. 7. Viscosity and temperature profile during transesterification reaction for canola feed.

temperature against time. Data were logged at 1 Hz for 1 h. The trend of the viscosity curve is similar to the one in the simulation plot shown in Fig. 2 where a huge drop in viscosity is indicated when the KOCH_3 was mixed with the canola oil. When the reaction reached equilibrium, the viscosity remained at a fairly low constant value. The temperature curve shows the temperature is maintained at 60 °C with small fluctuations. The drop of temperature was due to the addition of KOCH_3 , which was kept at room temperature before addition to the canola oil, and to the slightly endothermic nature of the transesterification reaction. Due to the response of the temperature control, the temperature may have a slight fluctuation during the reaction process. However, the fluctuations of the temperature do not have a significant effect on the viscosity change. When observing the physical appearances of the mixture after the settling process, the separation between the crude biodiesel and glycerol was clearly observed.

Waste vegetable oil contains higher concentration of fatty acids, water and impurities than pure canola oil does. These materials make the conversion more difficult due to side reactions. However, for the complete reaction of WVO to biodiesel, the acoustic wave sensor was able to monitor the reaction as indicated in Fig. 8. An occasional problem was observed when droplets of glycerine adhered to the surface of the sensor; this became a non-issue with vigorous mixing. It is, however, an issue worth considering when placing the sensor in the pilot scale reactor.

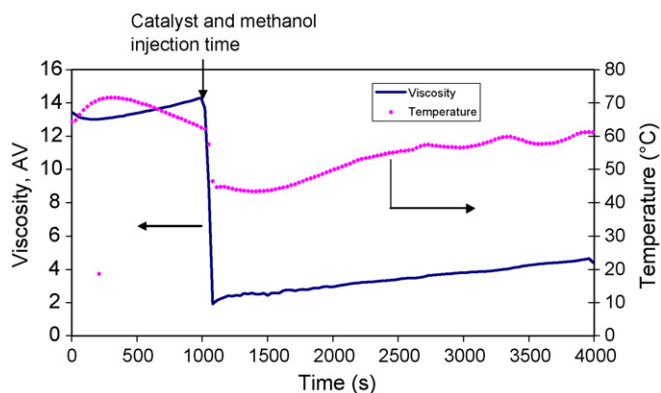

Fig. 8. Viscosity and temperature profile during transesterification reaction for waste vegetable oil feed.

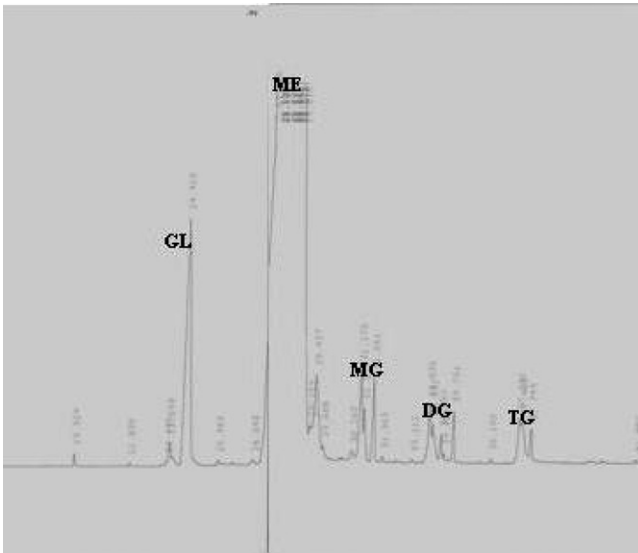

Fig. 9. Gas chromatogram of WVO biodiesel from complete reaction.

The products of the transesterification reactions were analyzed using a Hewlett-Packard 5890 with a flame ionization detector and a DB-5 capillary column (15 m × 0.32 mm ID). The temperature program was as follows: initial temperature of 45 °C was held for 1 min, and then increased at a rate of 5 °C/min to 300 °C and held for 15 min. The injector and detector temperatures were 290 and 310 °C, respectively, with no derivitization of the samples. The GC analysis confirmed that the reaction mixture contained mostly methyl ester with minor peaks representing mono-, di- and tri-glycerides, as shown in Fig. 9.

3.3. Pilot plant installation

The University of British Columbia currently has a biodiesel production facility that has the capacity to produce 300 L a day from waste vegetable oil (WVO). Fig. 10 shows the overall production scheme used in the UBC Biodiesel Project. Waste vegetable oil is collected from food outlets on campus and stored in 200 L drums. Firstly, the WVO is filtered through a screen to remove any particulates. Secondly, water is removed from the WVO by boiling it under a vacuum pressure of ~80 kPa at 60 °C. Meanwhile, methanol and KOH are mixed together at the ratio of 12 L methanol plus 450 g KOH to form KOCH₃. After the water is removed, the WVO feed is poured into the reactor along with the KOCH₃ to start the transesterification reaction. The temperature is kept at 60 °C and the reaction takes approximately 1 h. Once the reaction is completed, the reaction mixture will consist of methyl esters (biodiesel), glycerol, and excess methanol. After studying the characteristics of the acoustic wave viscometer at a bench top scale, we investigated the installation in the pilot plant. A rod with the sensor was installed through the top of the reactor. The materials were resistant to a wide range of pH values and prevented the leakage of gas vapours. The mixing blade did not interfere with the sensor and the design was such that measurements were independent of sensor location. Repeated experiments were carried out with 150 L of WVO, and 30 L of methoxide (30 L methanol and 0.6 kg KOH). Viscosity measurements were taken every 10 min for the 150 min duration. Due to the difficulty in controlling the reactor temperature, a significant drop in temperature was observed after the addition of methanol and catalyst. Despite the continual drop in temperature, the mixture's viscosity decreased until hitting a plateau as shown in Fig. 11. Thus, the transesterification reac-

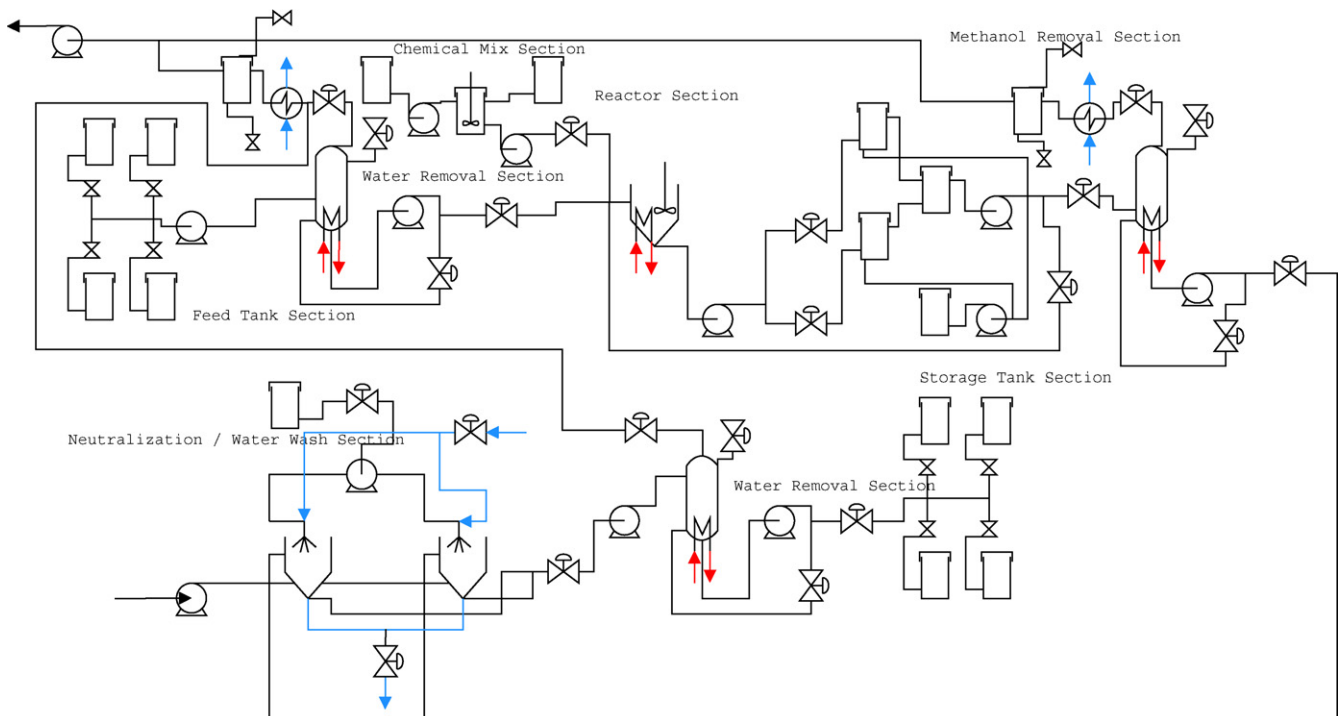

Fig. 10. Large scale biodiesel production scheme at University of British Columbia (adapted from [22]).

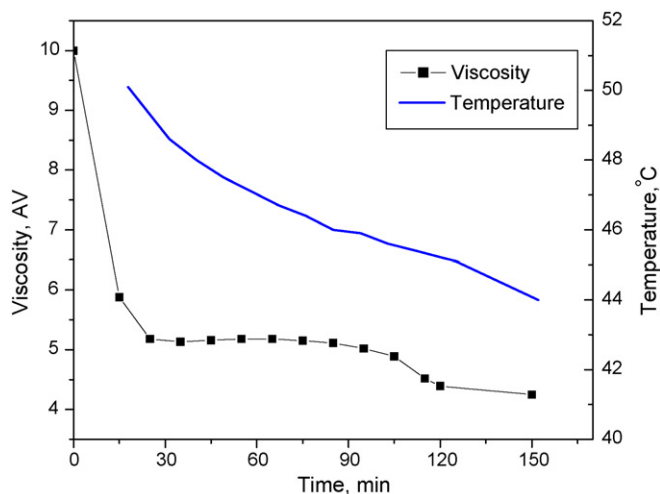

Fig. 11. Viscosity and temperature profile during transesterification reaction for waste vegetable oil feed in the pilot plant reactor.

tion was successfully monitored in a pilot scale reactor using an acoustic wave viscometer. By this in situ method, viscosity can now be a parameter for process control allowing more efficient conversion process.

4. Conclusions

The progress and end-point of the transesterification reaction during biodiesel production was successfully monitored using in situ viscosity measurements on three different scales. Using the rotary viscometer, the sensor cup served as both the reactor and mixer. Continuous monitoring of the viscosity as it decreased to a plateau in the viscosity curve revealed the progress of the reaction as it reached its end-point. Experimental data supported that an unsuccessful transesterification reaction will not display such a unique pattern. A commercially available acoustic wave viscometer, ViSmartTM, was then calibrated and tested in situ on a bench-top reactor. GC analysis of the final product revealed conversion of triglyceride to methyl ester (biodiesel) once the plateau in the viscosity curve was reached. Finally, in situ monitoring by the acoustic wave viscometer in the UBC Biodiesel pilot plant has shown its effectiveness in following the transesterification reaction of waste vegetable oil into biodiesel and glycerine.

Acknowledgements

The authors wish to express their gratitude to the Natural Science and Engineering Research Council (Canada) for funding. Furthermore, deep appreciation is express for the support of Mr. Karun Koernig and Mr. Andrew Gidora from the Environmental Youth Alliance in running the pilot plant, Mr. Dan McCormick from BiODE Inc. for in-depth consultation and conducting pro-

liminary experiments, and Mr. Steve Hosein for the insightful discussions and careful reading of the manuscript.

References

- [1] L.G. Schumacher, W. Marshall, J. Krahl, W.B. Wetherell, M.S. Grabowski, Biodiesel emissions data from Series 60 DDC engines, *Trans. ASAE* 44 (6) (2001) 1465–1468.
- [2] U. Doe, Alternative Fuel Price Report, June 1, 2006.
- [3] B. Freedman, W.F. Kwolek, E.H. Pryde, Quantitation in the analysis of transesterified soybean oil by capillary gas-chromatography, *J. Am. Oil Chem. Soc.* 63 (10) (1986) 1370–1375.
- [4] L.C. Meher, D.V. Sagar, S.N. Naik, Technical aspects of biodiesel production by transesterification—a review, *Renew. Sustain. Energy Rev.* 10 (3) (2006) 248–268.
- [5] G.F. Zagonel, P.G. Peralta-Zamora, L.P. Ramos, Production of ethyl esters from crude soybean oil: optimization of reaction yields using a 23 experimental design and development of a new analytical strategy for reaction control, *Preprints Symp.: Am. Chem. Soc. Div. Fuel Chem.* 47 (1) (2002) 363–364.
- [6] G. Knothe, Rapid monitoring of transesterification and assessing biodiesel fuel quality by near-infrared spectroscopy using a fiber-optic probe, *J. Am. Oil Chem. Soc.* 76 (7) (1999) 795–800.
- [7] B. Freedman, R.O. Butterfield, E.H. Pryde, Transesterification kinetics of soybean oil, *J. Am. Oil Chem. Soc.* 63 (10) (1986) 1375–1380.
- [8] G. Knothe, Monitoring a progressing transesterification reaction by fiber-optic near infrared spectroscopy with correlation to ¹H nuclear magnetic resonance spectroscopy, *J. Am. Oil Chem. Soc.* 77 (5) (2000) 489–493.
- [9] M.E. Tat, J.H. Van Gerpen, The kinematic viscosity of biodiesel and its blends with diesel fuel, *J. Am. Oil Chem. Soc.* 76 (12) (1999) 1511–1513.
- [10] E. Kleinschmidt, Continuous viscosity measurement in stirred vessels, *Paint Technol.* 33 (9) (1969) 34–44.
- [11] P.J. Cullen, C.P. O'Donnell, Process viscometry techniques for the food industry, Faculty of Agriculture Research Report, pp. 132–133, 2001.
- [12] P. De Filippis, C. Giavarini, M. Scarsella, M. Sorrentino, Transesterification processes for vegetable-oils—a simple control method of methyl-ester content, *J. Am. Oil Chem. Soc.* 72 (11) (1995) 1399–1404.
- [13] F. Ma, M.A. Hanna, Biodiesel production: a review, *Bioresour. Technol.* 70 (1) (1999) 1–15.
- [14] S. Saka, D. Kusciana, Biodiesel fuel from rapeseed oil as prepared in supercritical methanol, *Fuel* 80 (2) (2001) 225–231.
- [15] A. Demirbas, Biodiesel from vegetable oils via transesterification in supercritical methanol, *Energy Convers. Manage.* 43 (17) (2002) 2349–2356.
- [16] K. Komers, F. Skopal, R. Stloukal, J. Machek, Kinetics and mechanism of the KOH-catalyzed methanolysis of rapeseed oil for biodiesel production, *Eur. J. Lipid Sci. Technol.* 104 (11) (2002) 728–737.
- [17] L. Grunberg, A.H. Nissan, Mixture law for viscosity, *Nature (London, United Kingdom)* 164 (1949) 799–800.
- [18] C.A.W. Allen, K.C. Watts, R.G. Ackman, M.J. Pegg, Predicting the viscosity of biodiesel fuels from their fatty acid ester composition, *Fuel* 78 (11) (1999) 1319–1326.
- [19] F. Guan, Viscosity method for monitoring transesterification reaction of vegetable oils for biodiesel production, Master of Engineering Report, Department of Chemical and Biological Engineering, Vancouver, The University of British Columbia, 2004.
- [20] BiODE Inc., The eCup Handheld Viscometer Manual, WestBrook, BiODE Inc., 2003/2006.
- [21] K. Durdag, Solid-state viscometer for oil condition monitoring, *Practicing Oil Analysis Magazine*, 2004.
- [22] N. Woo, Large scale biodiesel production at UBC, Internal Report, Department of Chemical and Biological Engineering, Vancouver, The University of British Columbia, 2004.